







PART NUMBER	DRAWING	PRODUCT NAME	DESCRIPTION	CAT. NUMBER
1		<b>PANEL KIT (WITHOUT SENSOR)</b> 07040193	-	-
2		<b>10-PACK SENSOR KIT</b> 07220278	<b>INFRARED SENSOR</b>	<b>08002289</b>
3			<b>O-RING</b>	<b>04510173</b>
2		<b>INDIVIDUAL SENSOR KIT</b> 07220215	<b>INFRARED SENSOR</b>	<b>08002289</b>
3			<b>O-RING</b>	<b>04510173</b>
4		<b>10-PACK SOLENOID VALVE KIT 07232003</b>	<b>SOLENOID</b>	<b>07500059</b>
5			<b>O-RING</b>	<b>04530183</b>
4		<b>INDIVIDUAL SOLENOID VALVE KIT</b> 07230015	<b>SOLENOID</b>	<b>07500059</b>
5			<b>O-RING</b>	<b>04530183</b>
8		<b>18-PACK PISTON KIT</b> 07290104	-	-
8		<b>INDIVIDUAL PISTON KIT</b> 07290033	-	-
8		<b>3-PACK PISTON + PISTON COVER KIT</b> 07290110	<b>PISTON KIT</b>	<b>07290033</b>
7			<b>PISTON COVER KIT</b>	<b>07290032</b>
11			<b>SCREW</b>	<b>05060203</b>
8		<b>INDIVIDUAL PISTON + PISTON COVER KIT</b> 07290048	<b>PISTON KIT</b>	<b>07290033</b>
7			<b>PISTON COVER KIT</b>	<b>07290032</b>
11			<b>SCREW</b>	<b>05060203</b>
6		<b>PUSH BUTTON KIT</b> 07245018	-	-
9		<b>PUSH BUTTON KIT FOR PANEL</b> 07245003	-	-
10		<b>TRANSFORMER EU</b> 06522091	-	-

# Venus Comfort 2032E

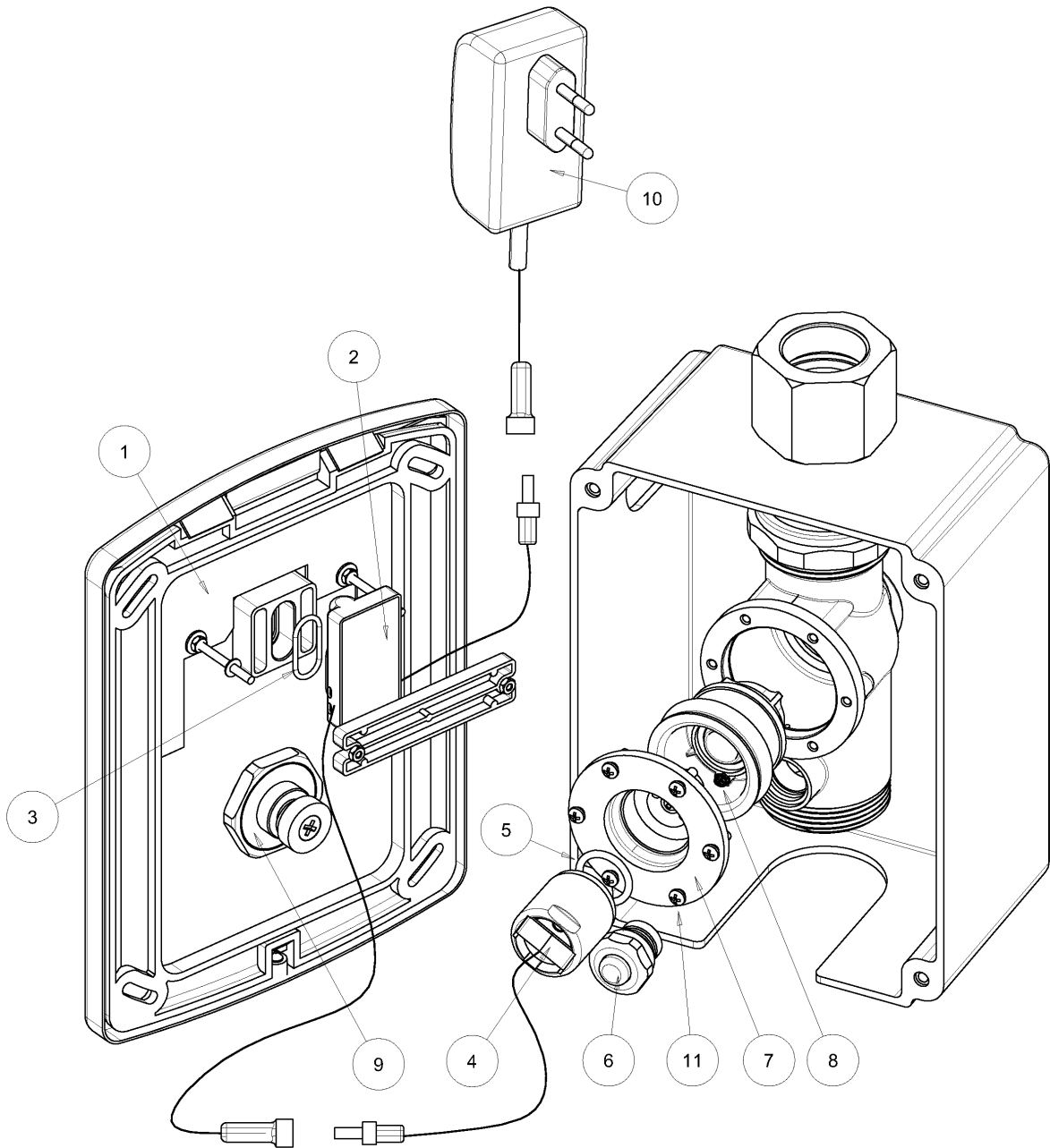

Y.STERN ENGINEERING LTD.